



Furniture for Learning Environments

EDUCATIONAL
FURNITURE
CATALOGUE

2019

For over 30 years, industrial designers at Workplace have been creating innovative high quality furniture for educational institutions

Workplace Furniture was started in 1985 by Industrial Designers from NID Ahmedabad and specialises in B2B Furniture Solutions. Dovetail Furniture currently operates in four business verticals Schools & Institutions, Home Furniture, Retail Shop Fitting and Office Furniture. To know more, visit www.workplace.ae

HOW TO USE THIS CATALOGUE

Each product in the catalogue has a unique base code. To place an order or to request a quotation, use the base code of the item you want in addition to a colour code provided at the back of the catalogue, in addition to the number of units you would like of each item. Different types of products have different colour options; the colour combinations are given in a matrix on page 48 - 51, and are labeled clearly for easy use.

Base code Add colour option
RIOCB70B ▶ RIOCB70BDAR

If you require any assistance, contact us at 080 6741 5599, or refer to the back cover to contact a sales person directly. All dimensions and measurements are in mm.

CONTENTS

KINDERGARTEN

DESKING p5

PRIMARY TO SECONDARY

DESKING p9

SEATING p16

LABORATORIES

CHEMISTRY p20 BIOLOGY p22 PHYSICS p24 DEMO TABLES p26
COMPUTER LABS p27

LIBRARIES

BOOK STORAGE p29 TABLES p32 ISSUE COUNTERS p34
ACCESSORIES p35

HOSTELS

STORAGE & TABLES p37 BEDS p38

LOUNGE & SOFT SEATING p40

STORAGE & ACCESSORIES p43

COLOUR OPTIONS p48

KINDERGARTEN

Organic and geometric shaped pre-school furniture in primary colours that brightens up and stimulates toddlers' play and learning. Our modular furniture lends itself to clusters of different sorts, allowing creative use of desks and storage.

Our design team experiments with colour, flexibility and practicality before presenting you the perfect kindergarten furniture solution at a convenient price point.



DESKING



To view available colours, please see page 48

Trapezoid



DIMENSIONS

DEPTH & WIDTH AS PER CHART

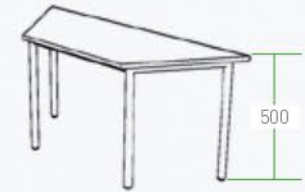

	Desk Depth and Width	Grade	Base Code
Trapezoid	450 x 900	Kindergarten	TRA50A
	600 x 1200	Kindergarten	TRA50B

Butterfly



DIMENSIONS

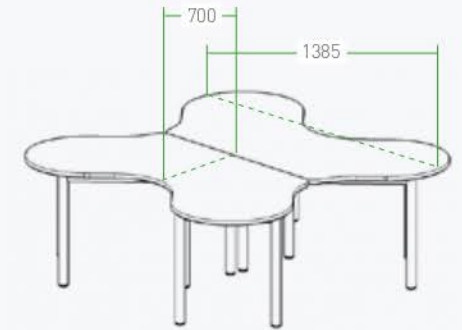

	Desk Height	Grade	Base Code
Butterfly	500	Kindergarten	BUT50

Rectangular



DIMENSIONS

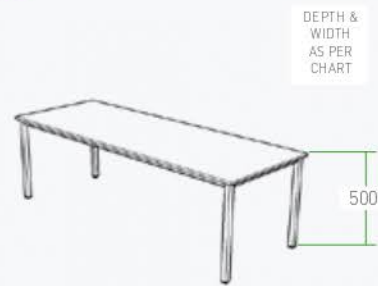

	Desk Depth & Width	Grade	Base Code
Rectangular	450 x 900	Kindergarten	REC50A
	450 x 1200	Kindergarten	REC50B

Semi Circle



DIMENSIONS

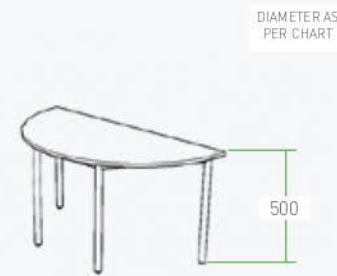

	Desk Diameter	Grade	Base Code
Semi Circle	900	Kindergarten	SEM50A
	1200	Kindergarten	SEM50B

Circular



DIMENSIONS



	Desk Diameter	Grade	Base Code
Circular	900	Kindergarten	CIR50A
	1200	Kindergarten	CIR50B

Bean



DIMENSIONS



	Desk Height & Grade	Base Code
Bean	500 (Kindergarten)	BEA50

Chowki



DIMENSIONS

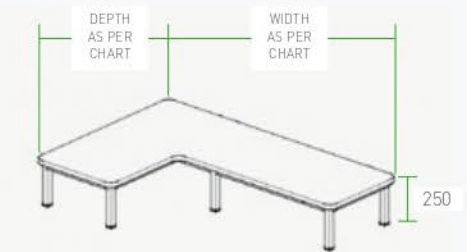

	Desk depth, width & Grade	Base Code
Chowki L shaped	1000 x 1500 (Kindergarten)	CHO1A25
	1200 x 1800 (Kindergarten)	CHO1B25



DIMENSIONS

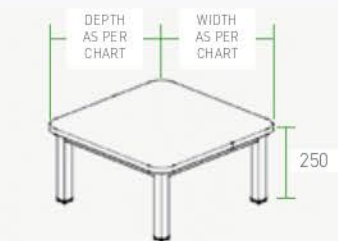

	Desk depth, width & Grade	Base Code
Chowki Square	500 x 500 (Kindergarten)	CHO2A25
	600 x 400 (Kindergarten)	CHO2B25
	600 x 600 (Kindergarten)	CHO2C25

PRIMARY to SECONDARY

For students in junior and senior school, storage options and the solidity of work desks & chairs is as important as the look and feel of classroom interiors. Our designers combine the best of both and adapt them to your needs, helping schools make studying fun and engaging. Research into children's behaviour gives us further insight into ideal design options for educational furniture.



DESKING



To view available colours, please see page 48

Cobalt

3 SEATER



DIMENSIONS

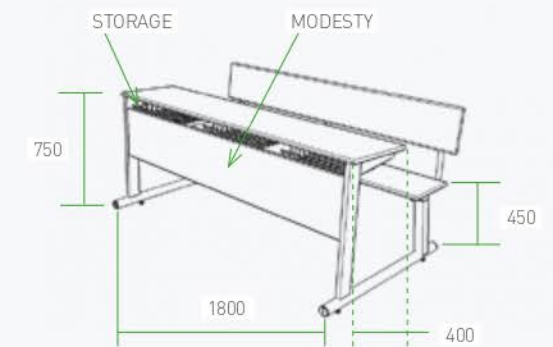

	Dimensions	Grade	Base Code	with Storage	with Storage & Modesty
Cobalt 3S	1800L x 400D x 750H	6th grade +	COBA75B	COBA75S	COBA75M

5 SEATER



DIMENSIONS

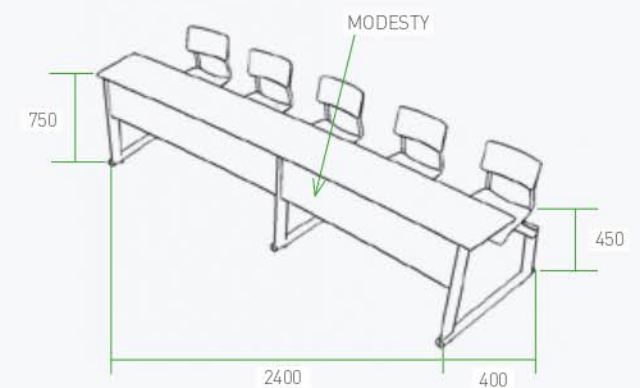

	Dimensions	Grade	Base Code	with Storage	with Storage & Modesty
Cobalt 5S	2400L x 400D x 750H	6th grade +	COBB75B	COBB75S	COBB75M

Rio Combo

2 SEATER



DRAWING



DIMENSIONS AS PER CHART

	Dimensions	Grade	Base Code	with Storage	with Storage & Modesty
Rio Combo	800L x 400D x 600H	1 - 3rd grade	RIOCA60B	RIOCA60S	RIOCA60M
	1100L x 400D x 700H	4 - 5th grade	RIOCA70B	RIOCA70S	RIOCA70M
	1200L x 400D x 750H	6th grade +	RIOCA75B	RIOCA75S	RIOCA75M

3 SEATER



DRAWING

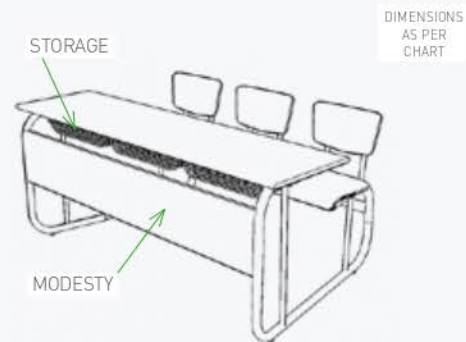

DIMENSIONS AS PER CHART

	Dimensions	Grade	Base Code	with Storage	with Storage & Modesty
Rio Combo	1650L x 400D x 700H	4 - 5th grade	RIOCB70B	RIOCB70S	RIOCB70M
	1650L x 400D x 750H	6th grade +	RIOCB75B	RIOCB75S	RIOCB75M

Stilt

2 SEATER



DRAWING

DIMENSIONS AS PER CHART

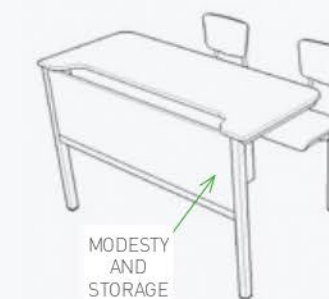

	Dimensions	Grade	Base Code	with Storage & Modesty
Stilt Combo	1200L x 995D x 600H	1 - 3rd grade	STIC60B	STIC60M
	1200L x 995D x 700H	4 - 5th grade	STIC70B	STIC70M
	1200L x 995D x 750H	6th grade +	STIC75B	STIC75M

Bolt

SINGLE SEATER

DOUBLE SEATER

DIMENSIONS

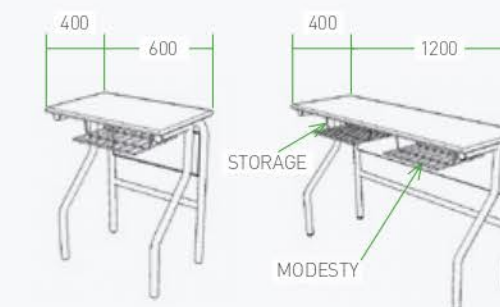

	Desk Height & Grade	Base Code	with Storage	with Storage & Modesty
Bolt single seater	600 (1 - 3rd grade)	BLTS60B	BLTS60S	BLTS60M
	700 (4 - 5th grade)	BLTS70B	BLTS70S	BLTS70M
	750 (6th grade +)	BLTS75B	BLTS75S	BLTS75M
Bolt double seater	600 (1 - 3rd grade)	BLTD60B	BLTD60S	BLTD60M
	700 (4 - 5th grade)	BLTD70B	BLTD70S	BLTD70M
	750 (6th grade +)	BLTD75B	BLTD75S	BLTD75M

Curvy

SINGLE SEATER

DOUBLE SEATER

DIMENSIONS

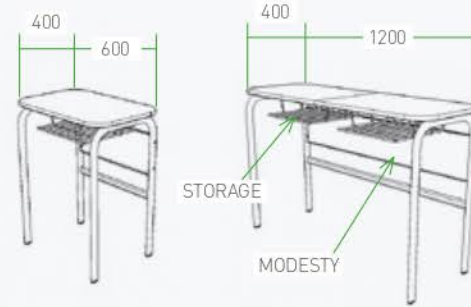

	Desk Height & Grade		Base Code	with Storage	with Storage & Modesty
Curvy single seater	600	(1 - 3rd grade)	CRVS60B	CRVS60S	CRVS60M
	700	(4 - 5th grade)	CRVS70B	CRVS70S	CRVS70M
	750	(6th grade +)	CRVS75B	CRVS75S	CRVS75M
Curvy double seater	600	(1 - 3rd grade)	CRVD60B	CRVD60S	CRVD60M
	700	(4 - 5th grade)	CRVD70B	CRVD70S	CRVD70M
	750	(6th grade +)	CRVD75B	CRVD75S	CRVD75M

Rio

SINGLE SEATER

DOUBLE SEATER

DIMENSIONS

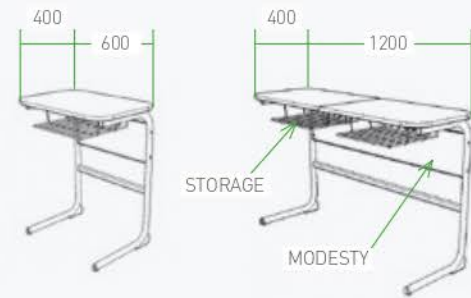

	Desk Height & Grade		Base Code	with Storage	with Storage & Modesty
Rio single seater	600	(1 - 3rd grade)	RIOS60B	RIOS60S	RIOS60M
	700	(4 - 5th grade)	RIOS70B	RIOS70S	RIOS70M
	750	(6th grade +)	RIOS75B	RIOS75S	RIOS75M
Rio double seater	600	(1 - 3rd grade)	RIOD60B	RIOD60S	RIOD60M
	700	(4 - 5th grade)	RIOD70B	RIOD70S	RIOD70M
	750	(6th grade +)	RIOD75B	RIOD75S	RIOD75M

Shine

SINGLE SEATER

DIMENSIONS



	Desk Height & Grade		Base Code	with Storage
Shine single seater	600	(1 - 3rd grade)	SHN60B	SHN60S
	700	(4 - 5th grade)	SHN70B	SHN70S
	750	(6th grade +)	SHN75B	SHN75S

Nordic

SINGLE SEATER

DIMENSIONS

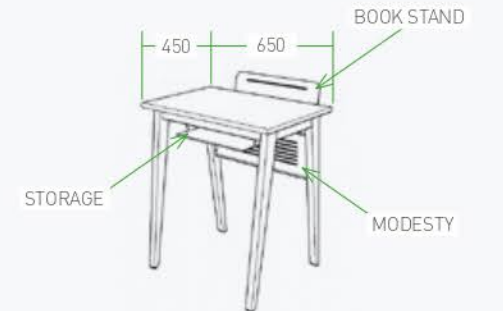

	Desk Height & Grade		Base Code	with Storage
Nordic single seater	600	(1 - 3rd grade)	NRD60B	NRD60S
	700	(4 - 5th grade)	NRD70B	NRD70S
	750	(6th grade +)	NRD75B	NRD75S

Candid table



Base Code

Candid CND

Basic teacher's table

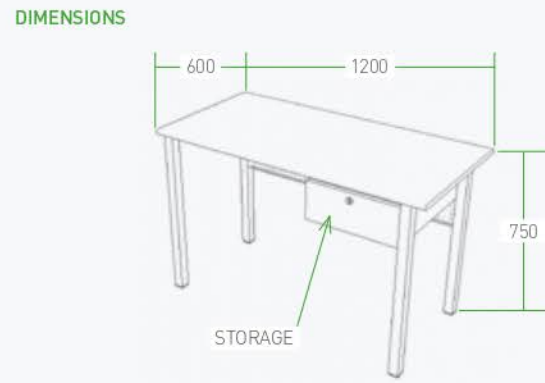

Base Code

Teacher's Table BTT

Principal's desk

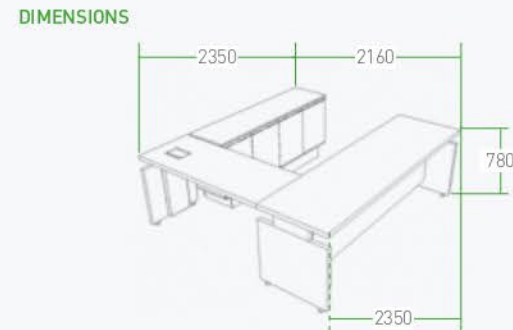

Base Code

Principal's desk PRCD



A range of furniture designed for different environments within a school campus, such as chairs for a library, seating for classrooms and stools for laboratories. Our chairs and stools are ergonomically designed and have a focus on comfort, quality and longevity.

SEATING

Fall Guy

(Also available in stainless steel)

DIMENSIONS

HEIGHT AS PER CHART



1 - 3 GRADE
360 385

4 - 5 GRADE
410 400

6 GRADE+
490 545



	Height	Grade	Base Code	Suggested Use
Fall Guy	300	Kindergarten	FAL30	Class, Library
	350	1 - 3 grade	FAL35	Class, Library
	400	4 - 5 grade	FAL40	Class, Library
	450	6 grade +	FAL45	Class, Library

Contour

DIMENSIONS

HEIGHT AS PER CHART



	Height	Base Code	Suggested Use
Elephant	450	CON45	Class, Library

Elephant

DIMENSIONS

HEIGHT AS PER CHART



	Height	Grade	Base Code	Suggested Use
Elephant	300	Kindergarten	ELE30	Class, Library

Wednesday

DIMENSIONS

HEIGHT AS PER CHART



1 - 3 GRADE
344 460

4 - 5 GRADE
393 527

6 GRADE+
442 550

	Height	Grade	Base Code	Suggested Use
Wednesday	350	1 - 3 grade	WED35	Class, Library
	400	4 - 5 grade	WED40	Class, Library
	450	6 grade +	WED45	Class, Library

Nordic

DIMENSIONS

HEIGHT AS PER CHART



	Height	Base Code	Suggested Use
Nordic	450	NRDC45	Classroom, Library

Pyramid

DIMENSIONS

HEIGHT AS PER CHART



1 - 3 GRADE
340 380

4 - 5 GRADE
390 436

6 GRADE+
460 515

	Height	Grade	Base Code	Suggested Use
Pyramid	350	1 - 3 grade	PYR35	Class, Library
	400	4 - 5 grade	PYR40	Class, Library
	450	6 grade +	PYR45	Class, Library

RSR Chair

DIMENSIONS

HEIGHT AS PER CHART



	Height	Base Code	Suggested Use
RSR	450	RSRC45	Lab, Library, Cafeteria

Alpaca

DIMENSIONS

HEIGHT AS PER CHART



1 - 3 GRADE
344 460

4 - 5 GRADE
393 527

6 GRADE+
442 550

	Height	Grade	Base Code	Suggested Use
Alpaca	400	4 - 5 grade	ALP40	Class, Library
	450	6 grade +	ALP45	Class, Library



Pisa



DIMENSIONS

HEIGHT AS PER CHART



	Height	Base Code	Suggested Use
Pisa	400	PSA40	Classroom, Library
	450	PSA45	Classroom, Library

Beaker



DIMENSIONS

HEIGHT AS PER CHART



	Height	Base Code	Suggested Use
Beaker	400	BKR40	Classroom, Library
	450	BKR45	Classroom, Library

Basic Stool



DIMENSIONS

HEIGHT AS PER CHART

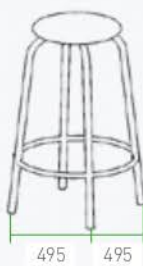

	Height	Base Code	Suggested Use
Basic Stool	550	STLR55	Lab, Library, Cafeteria
	655	STLR65	Lab, Library, Cafeteria
MDF Finish	550	STLM55	Lab, Library, Cafeteria
	655	STLM65	Lab, Library, Cafeteria



Well designed and cheerful school laboratory furniture that maximizes available space, complementing the curricular needs of students. The tables also come with provisions for running services such as power, gas, water and drainage.

LABORATORIES

CHEMISTRY



To view available colours, please see page 51

Axis

ISLAND HIGH BENCH



WALL HIGH BENCH



DIMENSIONS

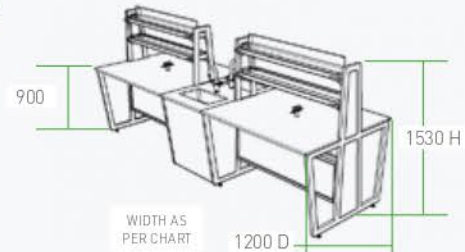

DIMENSIONS

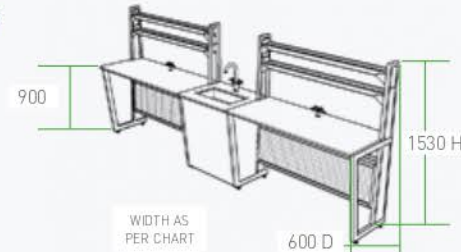

Ibis

ISLAND HIGH BENCH



WALL HIGH BENCH



DIMENSIONS

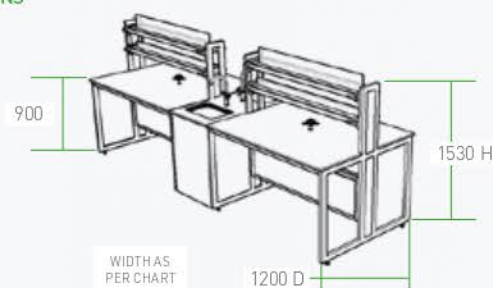

DIMENSIONS

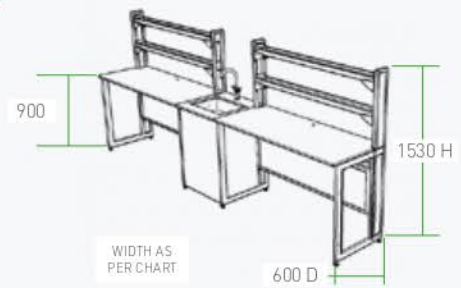

Available configurations

All our chemistry lab systems are customisable to the following widths and seating options. All of our laboratory systems include provisions for gas and water supply. Raceways are also provided when needed. Codes for each configuration are given next to the corresponding layout.

Island Tables (Axis/Ibis)

Wall Tables (Axis/Ibis)

1 2400 W (seats 4 children)
AXISIC1/IBSIC1

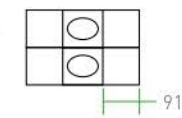

1 2400 W (seats 4 children)
AXISWC1/IBSWC1

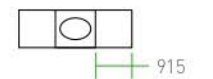

2 3000 W (seats 8 children)
AXISIC2/IBSIC2

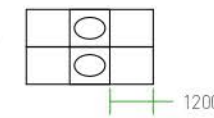

2 3000 W (seats 8 children)
AXISWC2/IBSWC2

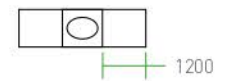

3 3600 W (seats 8 children)
AXISIC3/IBSIC3

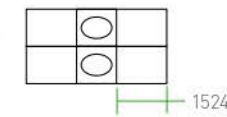

3 3600 W (seats 8 children)
AXISWC3/IBSWC3

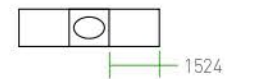

4 4800 W (seats 8 children)
AXISIC4/IBSIC4

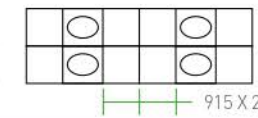

4 4800 W (seats 8 children)
AXISWC4/IBSWC44



5 6000 W (seats 16 children)
AXISIC5/IBSIC5

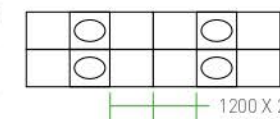

5 6000 W (seats 16 children)
AXISWC5/IBSWC5

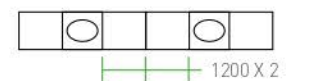

6 7200 W (seats 16 children)
AXISIC6/IBSIC6

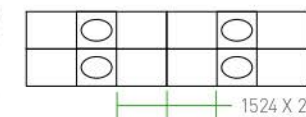

6 7200 W (seats 16 children)
AXISWC6/IBSWC6

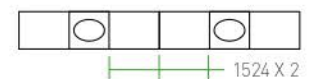

BIOLOGY



To view available colours, please see page 51

Axis

ISLAND HIGH BENCH



WALL HIGH BENCH



DIMENSIONS

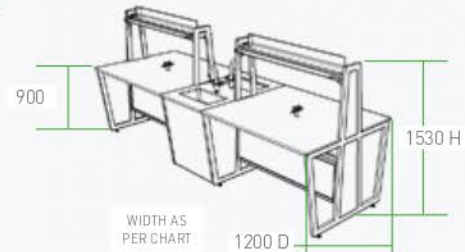

DIMENSIONS

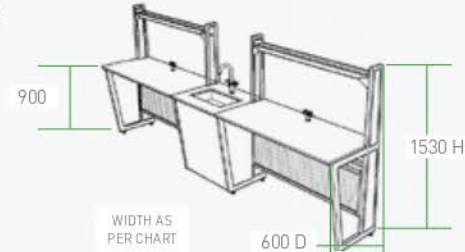

Ibis

ISLAND HIGH BENCH



WALL HIGH BENCH



DIMENSIONS

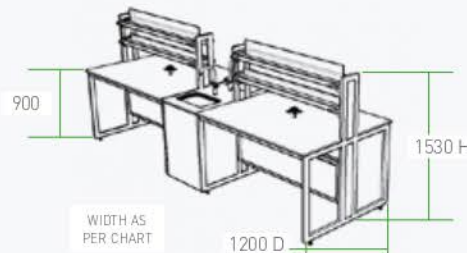

DIMENSIONS

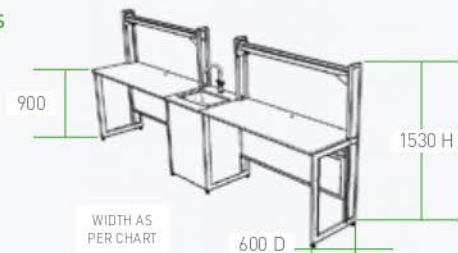

Available configurations

All our biology lab systems are customisable to the following widths and seating options. All of our laboratory systems include provisions for gas and water supply. Raceways are also provided when needed. Codes for each configuration are given next to the corresponding layout.

Island Tables (Axis/Ibis)

Wall Tables (Axis/Ibis)

1 2400 W (seats 4 children)
AXISIB1/IBSIB1

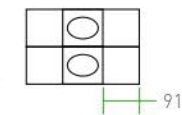

1 2400 W (seats 4 children)
AXISWB1/IBSWB1

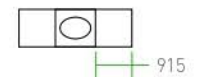

2 3000 W (seats 8 children)
AXISIB2/IBSIB2

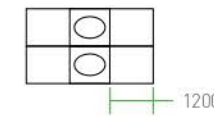

2 3000 W (seats 8 children)
AXISWB2/IBSWB2

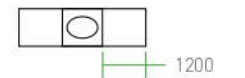

3 3600 W (seats 8 children)
AXISIB3/IBSIB3

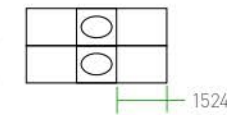

3 3600 W (seats 8 children)
AXISWB3/IBSWB3

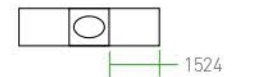

4 4800 W (seats 8 children)
AXISIB4/IBSIB4

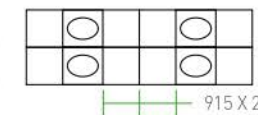

4 4800 W (seats 8 children)
AXISWB4/IBSWB4

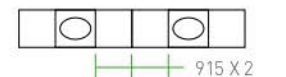

5 6000 W (seats 16 children)
AXISIB5/IBSIB5

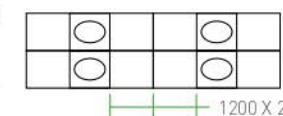

5 6000 W (seats 16 children)
AXISWB5/IBSWB5

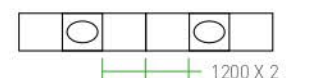

6 7200 W (seats 16 children)
AXISIB6/IBSIB6

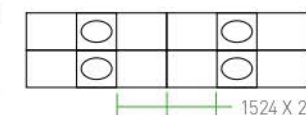

6 7200 W (seats 16 children)
AXISWB6/IBSWB6

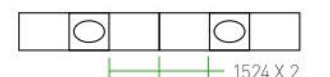

PHYSICS



To view available colours, please see page 51

Axis

ISLAND HIGH BENCH



WALL HIGH BENCH



DIMENSIONS

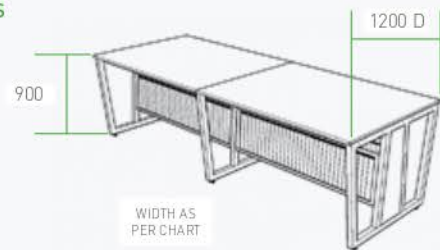

DIMENSIONS

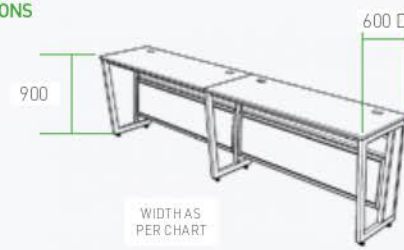

Ibis

ISLAND HIGH BENCH



WALL HIGH BENCH



DIMENSIONS

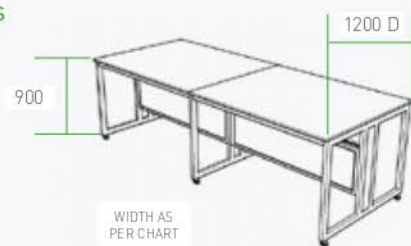

DIMENSIONS

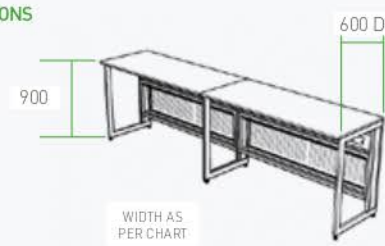

Available configurations

All our physics lab systems are customisable to the following widths and seating options. All of our laboratory systems include provisions for gas and water supply. Raceways are also provided when needed. Codes for each configuration are given next to the corresponding layout.

Island Tables (Axis/Ibis)

Wall Tables (Axis/Ibis)

1 2400 W (seats 4 children)
AXSIP1/IBSIP1

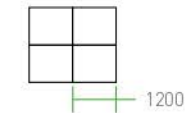

1 2400 W (seats 4 children)
AXSWP1/IBSWP1

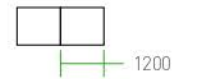

2 3000 W (seats 8 children)
AXSIP2/IBSIP2

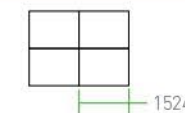

2 3000 W (seats 8 children)
AXSWP2/IBSWP2

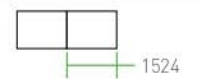

Running Counter

WITHOUT STORAGE



WITH STORAGE



DIMENSIONS

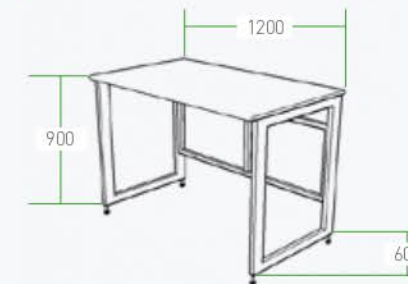

Base Code

Running Counter RUNA

DIMENSIONS

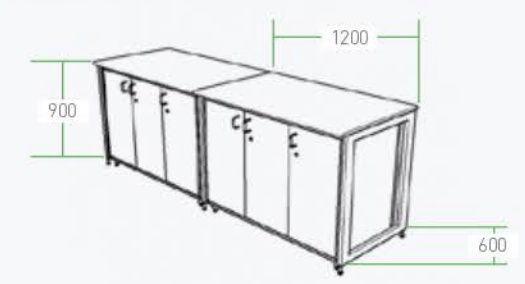

Base Code

Running Counter RUNB

DEMO TABLES



To view available colours, please see page 47

Axis

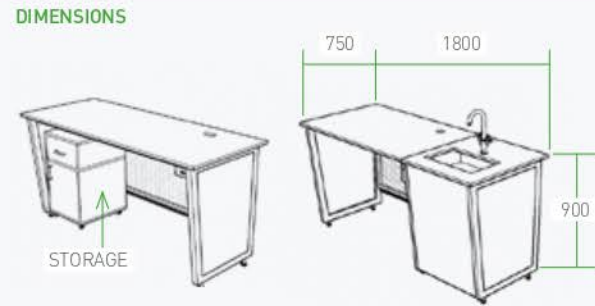

	Base Code	with Storage	with Sink
Axis demo table	AXD1	AXD2	AXD3

Ibis

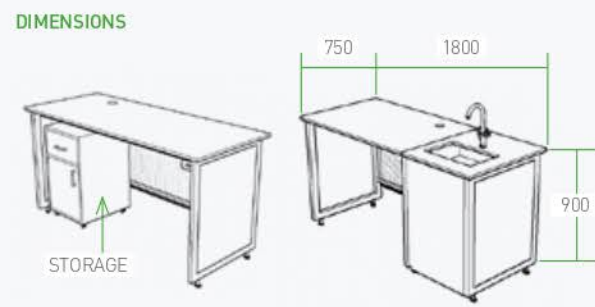

	Base Code	with Storage	with Sink
Ibis demo table	IBD1	IBD2	IBD3

Pedestal

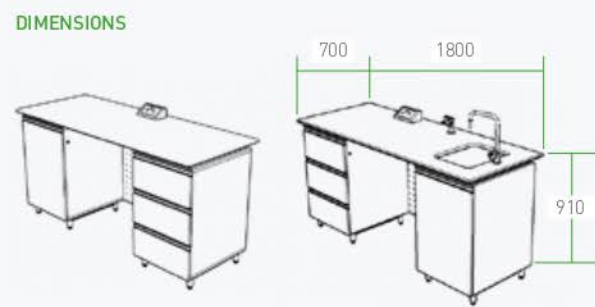

	Base Code	with Sink
Pedestal demo table	PDT1	PDT2

COMPUTER LABS



To view available colours, please see page 51

Base

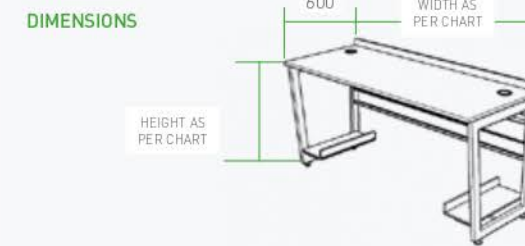

	Table Width	Table Height	Base Code
Base	900	650	BSCJ1
	1500	650	BSCJ2
	900	750	BSCS1
	1500	750	BSCS1

Dice

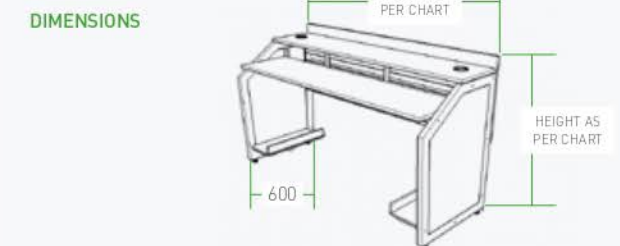

	Table Width	Table Height	Base Code
Dice	900	650	DCCJ1
	1500	650	DCCJ2
	900	750	DCCS1
	1500	750	DCCS1

Island

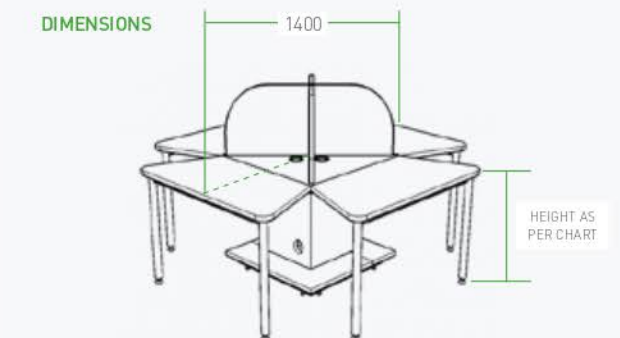

	Table Height	Base Code
Base	650	CCU1
	750	CCU2

LIBRARIES

Libraries are unique stores of knowledge, that require specialized furniture and systems to properly utilize and protect them. Our range of library furniture is designed to make storage of books adaptable and secure, while offering easy ways to transport and issue books.



BOOK STORAGE



To view available colours, please see page 49

Basic

SINGLE SIDED



DIMENSIONS

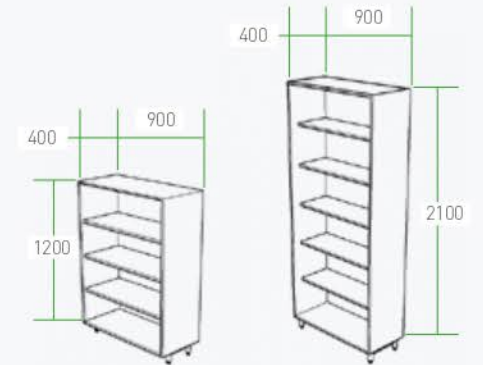

	Shelf Height	Base Code
Basic Shelving Single	1200	OPS1
	2100	OPS2

DOUBLE SIDED



DIMENSIONS

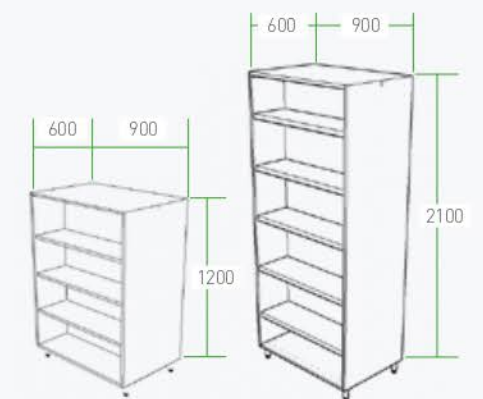

	Shelf Height	Base Code
Basic Shelving Double	1200	OPS3
	2100	OPS4

Cubix

SINGLE SIDED



DIMENSIONS

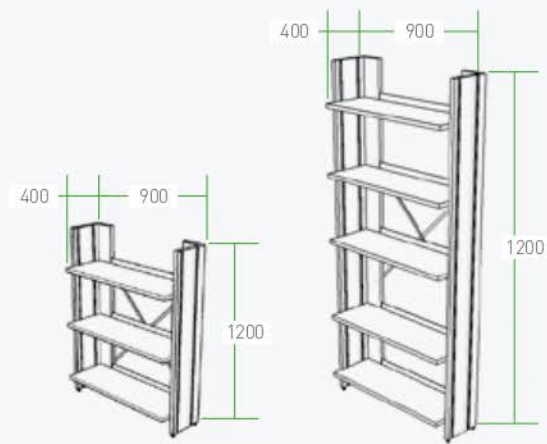

	Shelf Height	Base Code
Cubix Shelving Single	1200	CUBS1
	2100	CUBS2

DOUBLE SIDED



DIMENSIONS

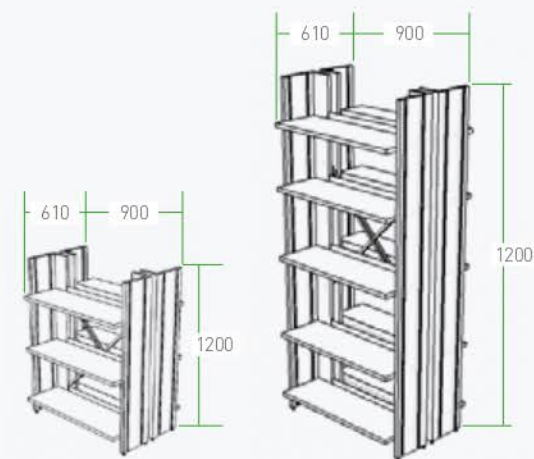

	Shelf Height	Base Code
Cubix Shelving Double	1200	CUBD1
	2100	CUBD2

Closed



DIMENSIONS



	Storage Height	Base Code
Closed Storage	1500	CLS1
	2100	CLS2

Magazine Display w/ Storage



DIMENSIONS

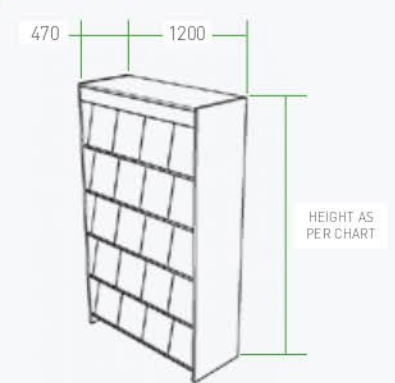

	Storage Height	Base Code
Magazine Display	1200	MGS1
w/ Storage	2100	MGS2

Magazine Display



	Base Code
Magazine Display	MGZ1

Book Trolley



	Base Code
Book Trolley	BKT1

TABLES



To view available colours, please see page 48

Trapezoid



DIMENSIONS



DIMENSIONS AS PER CHART

	Desk Height	Desk width	Depth	Base Code
Trapezoid	600	900	450	TRA60A
	600	1200	600	TRA60B
	750	900	450	TRA75A
	750	1200	600	TRA75B

Rectangular



DIMENSIONS



DIMENSIONS AS PER CHART

	Desk Height	Desk Width	Depth	Base Code
Rectangular	600	1800	750	REC60A
	600	1200	600	REC60B
	750	1800	750	REC75A
	750	1200	600	REC75B

Semi Circle



DIMENSIONS



DIMENSIONS AS PER CHART

	Desk Height	Desk Diameter	Base Code
Semi Circle	600	900	SEM60A
	600	1200	SEM60B
	750	900	SEM75A
	750	1200	SEM60B

Circular



DIMENSIONS



DIMENSIONS AS PER CHART

	Desk Height	Desk Diameter	Base Code
Circular	600	900	CIR60A
	600	1200	CIR60B
	750	900	CIR75A
	750	1200	CIR75B

ISSUE COUNTERS

Issue counter

L SHAPED

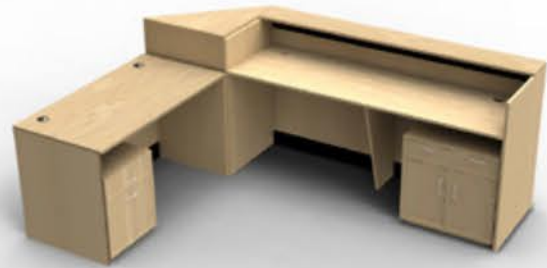

DIMENSIONS

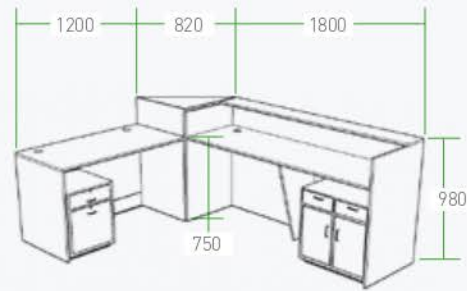

Base Code

L shaped Issue counter

ISC1

ISLAND



DIMENSIONS

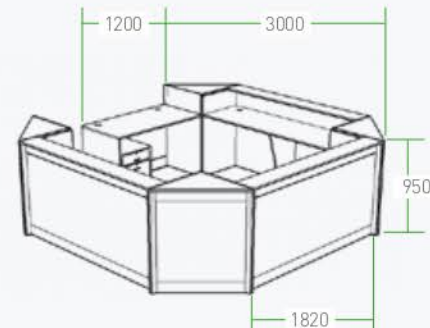

Base Code

Island Issue counter

ISC2

C SHAPED

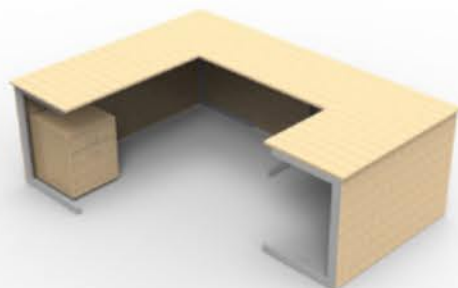

DIMENSIONS

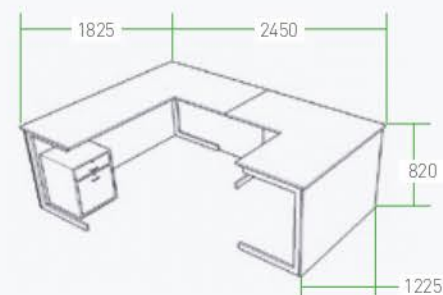

Base Code

C Shaped Issue counter

ISC3

ACCESSORIES



To view available colours, please see page 49

Map Stand



DIMENSIONS

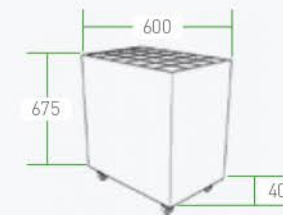

Base Code

Map Stand

MPS1

Newspaper Stand



DIMENSIONS

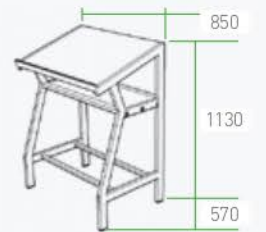

Base Code

Newspaper Stand

NWS1

Soft Board

To view available colours, please see page 43



Board Size Base Code

Soft Board	1200 x 1200	SFT1
	2400 x 1200	SFT2
	600 x 600	SFT3
	1800 x 1200	SFT4

Step Ladder



DIMENSIONS

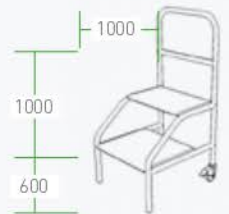

Board Size Base Code

Soft Board	1200 x 1200	SFT1
	2400 x 1200	SFT2
	600 x 600	SFT3
	1800 x 1200	SFT4

STORAGE & TABLES



To view available colours, please see page 51, 49



Workplace Furniture offers a variety of furniture solutions for hostels which are designed to be both simple and sturdy, and capable of multi-purpose use. Most of the furniture is a combination of wood and metal, lending it a home feel, while maintaining the ability to be used vigorously over a long period of time.

HOSTELS



Dorm Locker



DIMENSIONS



Base Code

Dorm Lockers

DML1

Individual locker dimension - 445L x 460D x 1950H

Side Table



DIMENSIONS

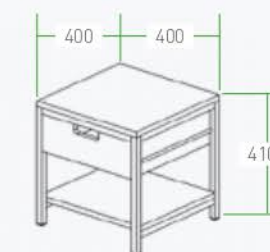

Base Code

Bunk Bed

SBT1

Study Table



DIMENSIONS

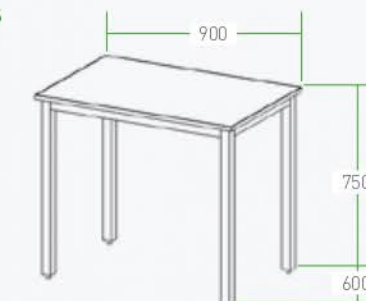

Base Code

Bunk Bed

STT1

BEDS

Bunk Bed combo



DIMENSIONS

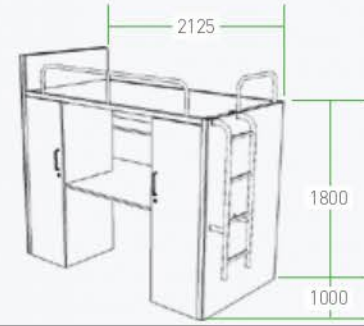

Base Code

Bunk Bed BUC1 Platform size: 1830L x 820D

Bed

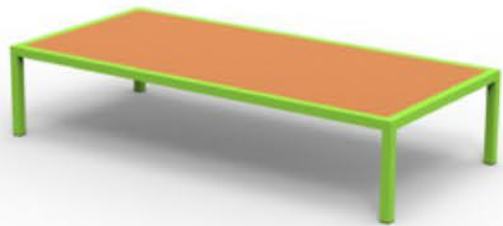

DIMENSIONS

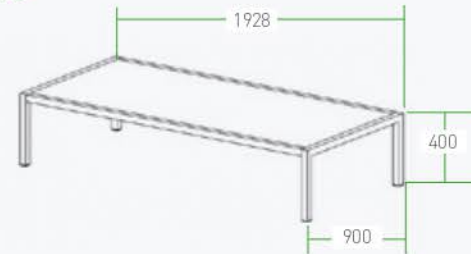

Base Code

Bed BAB1 Platform size: 1830L x 820D

Bunk Bed



DIMENSIONS

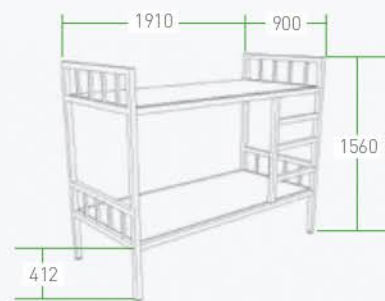

Base Code

Bunk Bed BUB1 Platform size: 1830L x 820D



LOUNGE & SOFT SEATING

Workplace Furniture has been manufacturing sofas and soft seating for well over twenty years and brings that experience to our school furniture range with an assortment of upholstered solutions that aim to be comfortable, yet durable and collaborative in nature at the same time. The designs have also been done in a way so as to offer multiple possible configurations depending on the furniture being used.

L Seating

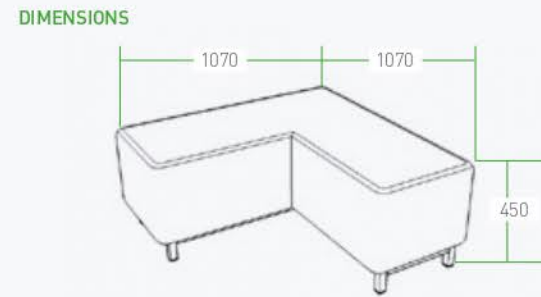
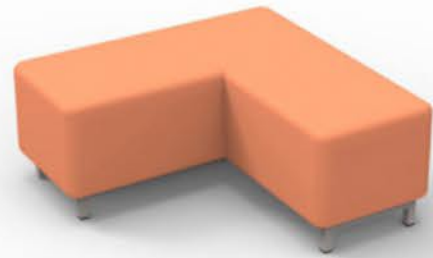

Base Code Seating height Seating Depth

L Seating LST1

United Sofa combo

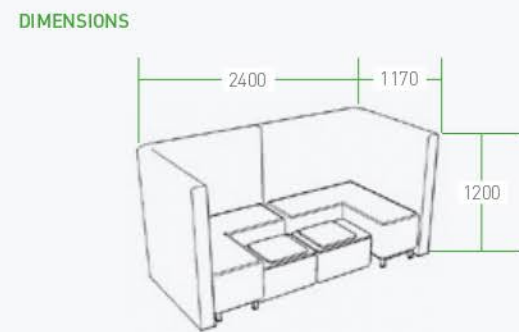
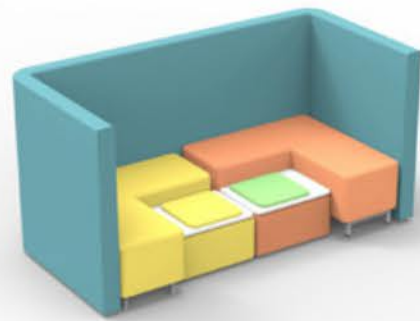

Base Code Seating height Seating Depth

United Sofa Combo UNSC1

Dove

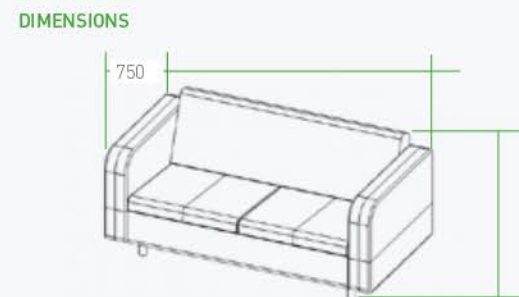

Base Code Seating height

Dove Sofa DOV1 350

Ridge

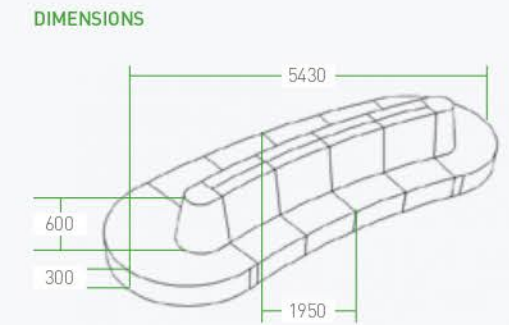
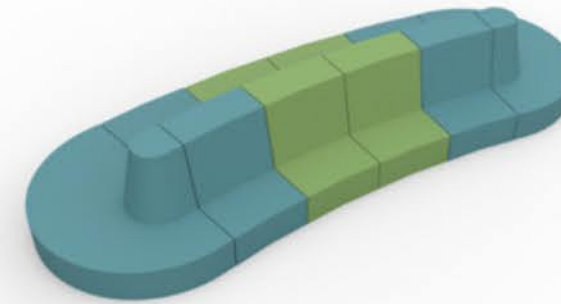

Base Code Seating height

Ridge RID1

Trigon

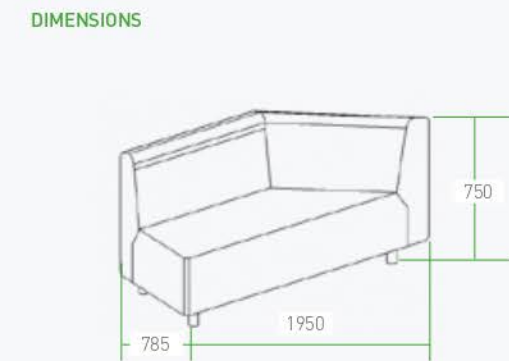
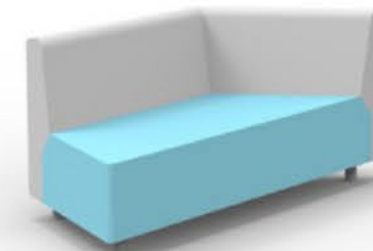

Base Code Seating height

Trigon Sofa TRG1

Possible configurations

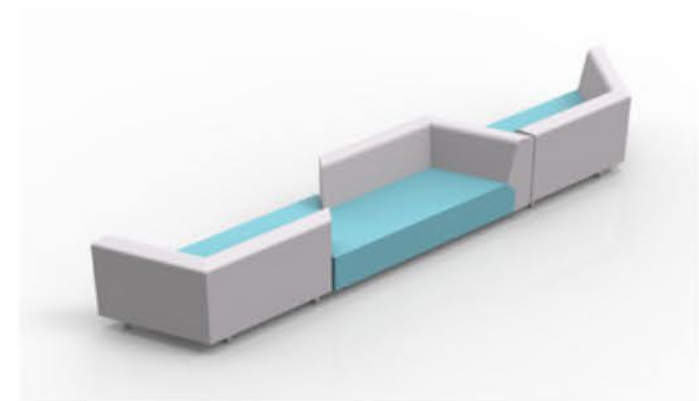
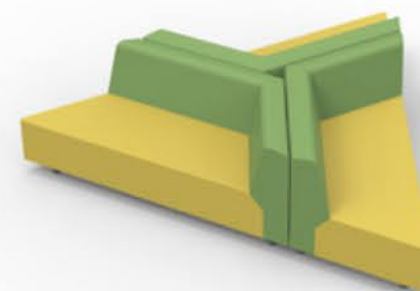

STORAGE & OTHER FURNITURE

Different school environments have a varying range of miscellaneous items required to complete it. With this in mind, Workplace has designed a range of storage and accessories, to fulfill any school's needs; from lab trolleys to lockers for teachers and student alike and many more in between.



To view available colours, please see page 49 - 51

Teacher's Locker



	No. of Spaces	Base Code
Teacher's Locker	12	TLO1

Individual cubby dimension - 400 H x 275 L

Teacher's Storage



	Base Code
Teacher's Storage	TCS

Personal Locker



	No. of Spaces	Base Code
Personal Locker	12	PLO1

Individual cubby dimension - 400H x 275L

Baggage Counter

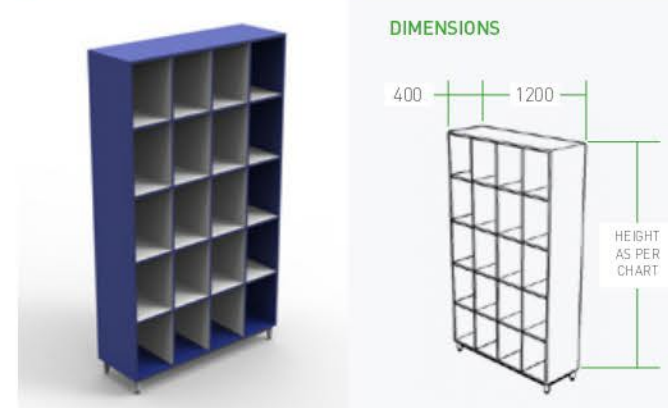

	Height	No. of Spaces	Base Code
Baggage counter	2100	20	BAG7
	1200	12	BAG4

Individual cubby dimension - 380H x 280L

Tablet Chair

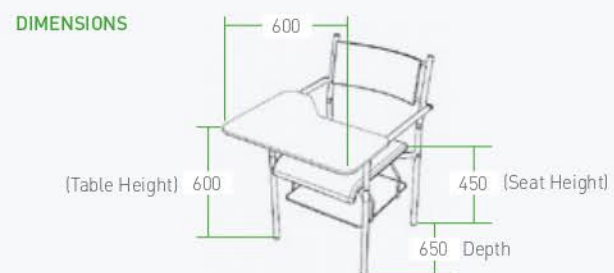

Base Code

Tablet Chair	TABC
--------------	------

Slotted Rack

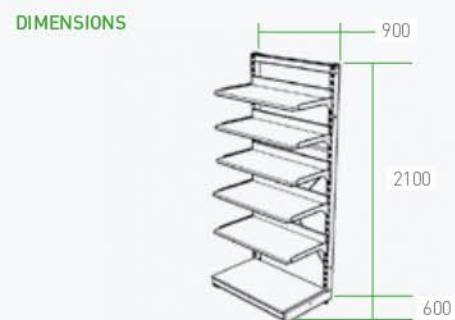

Shelf Material Base Code

Slotted Rack	Sheet Metal	SLR1
	Plywood	SLR2

Pedestal



Base Code

Pedestal Storage	PED02
------------------	-------

Overhead Storage



Storage width

Base Code

Overhead Storage Open	900	OHSA1
	1200	OHSA2



Storage width

Base Code

Overhead Storage Semi Closed	900	OHSB1
	1200	OHSB2



Storage width

Base Code

Overhead Storage Closed	900	OHSC1
	1200	OHSC2

Storage Box



DIMENSIONS

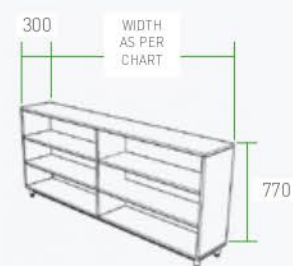

	Width	No. of Spaces	Base Code
Storage Box	1800	6	STB6
	900	3	STB3

Easel



DIMENSIONS

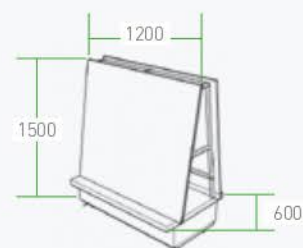

Base Code

Easel EAS

Mobile Whiteboard



DIMENSIONS

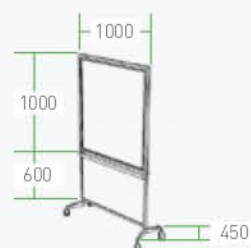

Base Code

Mobile Whiteboard MOBW1

COLOUR
OPTIONS &
FINISHES

HOW TO USE THIS CATALOGUE

Each product in the catalogue has a unique base code. To place an order or to request a quotation, use the base code of the item you want in addition to a colour code provided at the back of the catalogue, in addition to the number of units you would like of each item. Different types of products have different colour options; the colour combinations are given in a matrix on page 41-44, and are labeled clearly for easy use.

Base code Add colour option
RIOCB70B ▶ RIOCB70BDAR

If you require any assistance, contact us at 080 6741 5599

We try to ensure that every pattern and colour is accurately represented, however there could be slight variations in the final product. For accurate colours, please ask for physical samples.

COLOURS

DESKING - PRIMARY & KINDERGARTEN (Applicable for all desks)



Code:	AGR
Table Top	Asian Maple
Structure	Light Grey
Modesty	Red



Code:	YGY
Table Top	Yellow
Structure	Light Grey
Modesty	Yellow



Code:	BGB
Table Top	Blue
Structure	Light Grey
Modesty	Blue



Code:	GLG
Table Top	Green
Structure	Light Grey
Modesty	Green



Code:	RGR
Table Top	Red
Structure	Light Grey
Modesty	Red

COLOURS

STORAGE, ACCESSORIES & COMPUTER TABLES

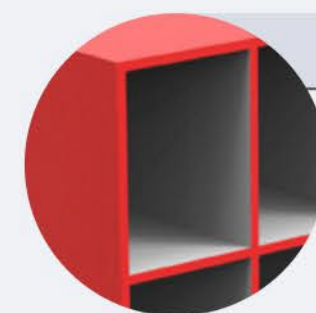

Code:	RWR
Surface	Red
Inside	White
Edge Banding	Red

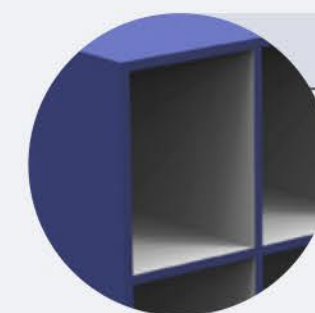

Code:	BWB
Surface	Blue
Inside	White
Edge Banding	Blue



Code:	GWG
Surface	Green
Inside	White
Edge Banding	Green

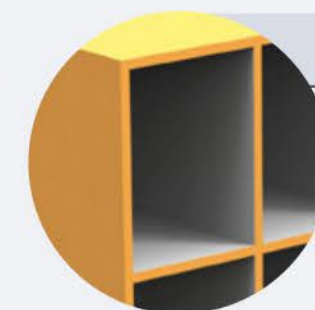

Code:	YWY
Surface	Yellow
Inside	White
Edge Banding	Yellow

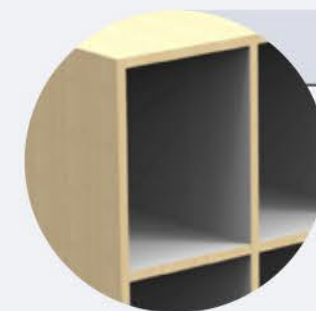



Code:	AWA
Surface	Asian Maple
Inside	White
Edge Banding	Asian Maple

COLOURS

SEATING





All chairs (except RSR)





Colour 1 Seat & Backrest	Colour 2 Frame	Colour Combo	Code
		Asian Maple, Light Grey	AL

Colour options for RW





Colour Combo	Code
Rubber Wood Natural Finish 	NF

SOFT BOARDS

Colour 1 Fabric	Colour 2 Frame	Colour Combo	Code
		Rubber Wood, Red	LAR
		Rubber Wood, Maroon	DAR





Colour 1 Fabric	Colour 2 Frame	Colour Combo	Code
		Rubber Wood, Green	LAR
		Rubber Wood, Blue	DAR





UPHOLSTERY

Colour Code	Orange ORF	Green GRF	Blue BLF	Grey GYF	Yellow YLF
					





COLOURS

LAB UNITS & DEMO TABLES











Colour 1 Frame	Colour 2 Highlights	Colour Combo	Code
		Light Grey, Red	LR
		Light Grey, Blue	LB

Colour 1 Frame	Colour 2 Highlights	Colour Combo	Code
		Light Grey, Yellow	LY
		Light Grey, Green	LG

SLOTTED RACK

Colour 1 Frame	Colour 2 Shelf	Colour Combo	Code
		Light Grey, Light Grey	LL
		White, White	WW

PERSONAL LOCKERS

Colour 1 Frame	Colour 2 Front	Colour Combo	Code
		Light Grey, Red	LR
		Light Grey, Blue	LB
		Light Grey, Yellow	LY
		Light Grey, Green	LG
		Light Grey, Dark Grey	LD

MATERIAL SPECIFICATIONS

SURFACE			STRUCTURE		
Material	Lamination	Edge	Pipe Section	Sheet Metal	Finish
Desking- Kindergarten					
18mm pre-laminated MDF	1mm, 0.6mm balancing white	PVC Edge Banding 2mm thick, Wood Beading 5mm Rubber Wood	1.6mm thick	1.2mm thick	Powder Coated 60-80 microns thick
Desking- Primary to Secondary					
18mm pre-laminated MDF	Post formed laminate 0.6mm, 0.6mm balancing white	Post formed, Edge Banding 2mm thick	1.6mm thick	1.2mm thick	Powder Coated 60-80 microns thick
Storage					
18mm pre-laminated MDF	1mm, 0.6mm balancing white	PVC Edge Banding 2mm thick, Wood Beading 5mm Rubber Wood	1.6mm thick	1.2mm thick	Powder Coated 60-80 microns thick
Accessories					
18mm pre-laminated MDF	1mm, 0.6mm balancing white	PVC Edge Banding 2mm thick, Wood Beading 5mm Rubber Wood	1.6mm thick	1.2mm thick	Powder Coated 60-80 microns thick
Laboratory					
18mm pre-laminated MDF, 19mm Granite	1mm, 0.6mm balancing white	PVC Edge Banding 2mm thick	1.6mm thick	1.2mm thick	Powder Coated 60-80 microns thick

Frame	Pipe Section	Seat and Backrest
Seating		
Mild Steel, Rubber Wood	1.6mm	12mm Bent Ply, Rubber Wood

TESTIMONIALS

Headstart Educational Academy

Like its name suggests - Dovetail - we have worked together in a partnership, fitting in needs and functionality, design and practicality. We are enjoying the furniture supplied and also enjoy the courtesy and consideration with which it is collaboratively planned and delivered.

Sushma
Head - Administration
Headstart Educational Academy

St. Dominic Savio High School

Dovetail to the rescue!

It had been a dream to change the furniture of our school, from a teacher centered model to a student centered one.

Finding the right furniture that would fit within our budget was a real nightmare and a marathon challenge. We tried many vendors but none could provide us with a solution to enable us to comfortably fit 66 students in a class.

Finally, Dovetail came up with a design that could fit 55. With a day-long meeting at the factory and adjustments in the design we reached the desired number of 66.

Thanks to the people at Dovetail we were able to keep our word to the parents and in a matter of just three months change the furniture of all the 20 classrooms in our school. Not a small task indeed!

Today our school has a totally different look. The kids are excited, the parents are thrilled and the teachers are so enthused about teaching in this redesigned classroom environment. Thank you Dovetail - you make dreams come true.

Fr. Crispino D'Souza
Principal
St. Dominic Savio High School

Harvest International School

We are very happy for having associated with Dovetail since our inception. They address all our needs in terms of innovative layouts, imaginative designs, safe and high quality furniture for all age groups of our school.

Their furniture has enhanced the beauty of our school interiors as they are aesthetically pleasing, child friendly and strong. They brighten up our classrooms and make them visually appealing for our children as well as teachers. Most of our parents and visitors have admired and complimented these.

Dovetail furniture is purpose built and ergonomically designed and hence we find them very comfortable. In a way it has enhanced active teaching and learning in our stimulating international school environment.

I have worked with many schools/ educational institutions in India and abroad. My personal feeling is that Dovetail has transformed the concept of school interiors. Our labs, library and classrooms have undergone a revolution with this furniture in terms of functionality, durability and easy maintenance. Most of all, we are very happy with their after sales service which is the key factor because of which I have recommended them to many other schools.

Dr. Dakshayini Kanna
Head of School & Principal
Harvest International School

APL Global School

Our school had some specific furniture in specific area and colours, apart from regulars on board. Dovetail furniture customized the furniture to our requirement, unique and exactly what we wanted. Good quality and great price. Sales very good and quick response. Thank you.

Chandrika
Operations Head & HR Head
APL Global School

OUR CLIENTS

A S PATIL COLLEGE OF COMMERCE | AGA KHAN ACADEMY | AMAATRA ACADEMY | AMEYA INTERNATIONAL SCHOOL | ANAN KIDS ACADEMY | APL GLOBAL SCHOOL | ASHOK LEYLAND SCHOOL | A V EDUCATIONAL SOCIETY | BRIGADE INTERNATIONAL SCHOOL | CAMBRIDGE INTERNATIONAL SCHOOL | CANDOR INTERNATIONAL SCHOOL | CHRISTEL HOUSE | CHRYSALIS HIGH | CIS PUNJAB SCHOOL | CLARENCE SCHOOL | CMR NATIONAL PUBLIC SCHOOL | CREYA LEARNING | DECCAN INTERNATIONAL SCHOOL | DPS INTERNATIONAL SCHOOL | DR BANSI DHAR SCHOOL | EDIFY SCHOOL | EKYA SCHOOL | EMERALD INTERNATIONAL SCHOOL | EPISTEMO GLOBAL SCHOOL | EURO KIDS | FREEDOM INTERNATIONAL SCHOOL | GEDEE PUBLIC SCHOOL | GEEKAY INTERNATIONAL SCHOOL | GEETANJALI OLYMPIAD SCHOOL | HARSHA INTERNATIONAL PUBLIC SCHOOL | HARVEST INTERNATIONAL SCHOOL | HEAD START MONTESSORI HOUSE OF CHILDREN | HERITAGE ACADEMY | HINDUSTAN INTERNATIONAL SCHOOL | INDIAN INSTITUTE OF INFORMATION TECHNOLOGY | INDIAN INSTITUTE OF MANAGEMENT | INSTITUTE OF BIOINFOMATICS & APPLIED BIOTECHNOLOGY | INVENTURE ACADEMY | KAIRALEENIKETAN EDUCATION TRUST | JAIN GROUP OF INSTITUTIONS | KANGAROO KIDS | KARA FOR KIDS | K E S AUSTIM CENTRE | KINDLE EXPERIENTIAL LEARNING PRIVATE LIMITED | K P R ENGINEERING COLLEGE | KUMARAN SCHOOL | LEGACY SCHOOL | MALLYA ADITI INTERNATIONAL SCHOOL | MAYOOR SCHOOL | MILLENNIUM EXCEL ACADEMY | MOTHER TERESA SCHOOL | MVJ COLLEGE OF ENGINEERING | NAGARJUNA EDUCATION SOCIETY | NANDI SHIKSHANA SANGHA | NEEV ACADEMY | NEEV PRE-SCHOOL | NES P U COLLEGE | NOTRE DAME ACADEMY | NASR SCHOOL | OMNIBUS LEARNING AND EDUCATION | ONKAR EDUCATION ACADEMY | OPEN MINDS SCHOOL | PESIT SCHOOL | R V SCHOOL | RAJAGIRI PUBLIC SCHOOL | RAMANIYAM SANKARA SCHOOL | RED HILLS HIGH SCHOOL | RIVERSIDE SCHOOL | ROYAL CONCORDE INTERNATIONAL SCHOOL | S A SAMAD EDUCATIONAL TRUST | SAMASHTI SCHOOL | SETH M R JAIPURIA SCHOOL | SHARADA MANDIR | SHIV NADAR SCHOOL | SILVER OAKS SCHOOL | SOUTHCITY INTERNATIONAL SCHOOL | SPARKHILL INTERNATIONAL SCHOOL | SREE RAMA VIDYALAYA | SRI AUROBINDO MEMORIAL SCHOOL | SRI B M PATIL PUBLIC SCHOOL | SRI KUMARAN CHILDREN'S HOME | SRI PRAKASH VIDYANIKETAN | SRI SRI RAVISHANKAR VIDYA MANDIR TRUST | SRI VANI EDUCATION SOCIETY | SRISHTI SCHOOL OF ART, DESIGN & TECHNOLOGY | STONE HILL INTERNATIONAL | SURANA VIDYALAYA | SWARGIYA HARBAJAN SINGH CHAWLA | SMRITI SEVA SANSTHAN | TEJAS INTERNATIONAL EDUCATIONAL INSTITUTIONS | THE CHOICE SCHOOL | THE GEEKAY WORLD SCHOOL | TREAMIS WORLD SCHOOL | UNNATI TRUST | VALLEY SCHOOL | VIDYANIKETAN PUBLIC SCHOOL | W E SCHOOL

→ 30 years and counting

→ 35000 sq ft factory area

→ 185 people strong

In addition to designing, manufacturing and installing furniture for schools, Dovetail also services clients who require retail shopfitting and fixtures, customised office furniture solutions and furniture for homes and hospitality. Please check our website at www.workplace.ae to learn more.



For enquiries related to retail shopfitting please send an email to info@workplace.ae or call +971 56 270 8641 | +971 50 671 2599

For enquiries related to Offices or Hospitality please send an email to info@workplace.ae or call +971 56 270 8641 | +971 50 671 2599



CONTACT US!

+971 50 671 2599

www.workplace.ae

sales03@workplace.ae | sales04@workplace.ae

Workplace Furniture Trading Ilc, 113 - 34 Sai Business Center,
Al Makhawi Building, Umm Hurair Street, Oud Metha,
Dubai, UAE, Po Box 80744.